

MTC-2 can work alone as a twin motor ECS (electronic speed controller) for RC tanks. When the ACU (auxiliary control unit) is connected, it can also control turret rotation, gun elevation, gun firing, machine gun firing and engine sounds. When the GSU (gun stabilize unit) is connected, ACU can stabilize gun elevation and turret rotation. This manual explains operations of MTC-2 and ACU. For GSU operation, see separate GSU manual.

MTC-2 highlight features:

- MTC-2 can work alone as a twin motor ESC, with 8A continuous current for 130 to 280 size motors.
- Continuous speed changes with forward, reverse, left, right and pivot turn.
- ECS brake function, motors can stop instantly.
- 5, 4 or 2 channel receiver options. 2 channel for standalone ESC, 4 channel for ECS and turret control. CH 5 is used for optional GSU on/off.
- Simple one button setup procedure.
- Battery options: 1-2 Cell Lipo (3.7 – 7.4V), 4-6 Cell NiMH (4.8-7.2V)
- Auto shutdown at low battery.
- Dimension (PCB): 38 x 25 x 20mm (1.5" x 1" x 0.8")

ACU highlight features:

- Three servo ports for turret rotation, gun elevation and gun barrel recoil.
- Support optional GSU (gun stabilize unit). See separate GSU manual for details.
- Main gun led and machine gun led flashes.
- 22KHz high quality digital sound effects, including main gun sound, machine gun sound and engine sound.
- Engine sound includes engine start, stop, idle, and running. Engine sound changes according to speed. Engine sound can be turned off by jumper.
- Turret rotation can be replaced by gun left/right motion by jumper setting.
- Gun return to reload position after fire (can be disabled by jumper).
- ACU size 38 x 25 x 12mm (1.5"x1"x0.5")

Contents

MTC-2 parts	_____	3
ACU parts	_____	3
Typical MTC-2 and ACU connections	_____	4
Transmitter Stick Modes	_____	5
Setup Procedures of MTC-2	_____	5
Setup Gun Reload Position	_____	6
Reset to Factory Settings	_____	6
Track Motion Control	_____	6
Brake Function	_____	6
Turret Motion Control	_____	7
Engine Sound Control	_____	7
Input Voltage	_____	7
Troubleshooting	_____	8

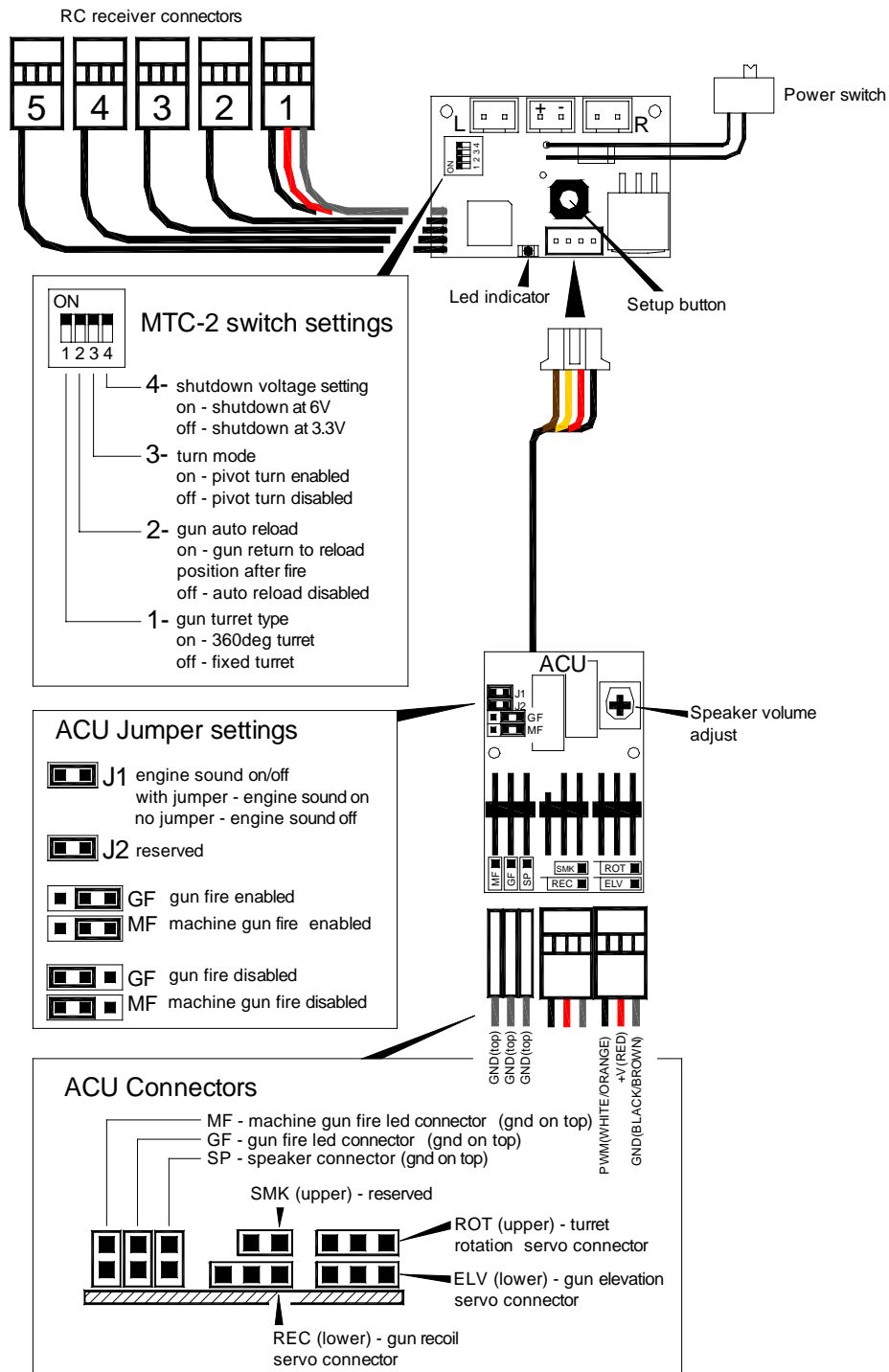

Fig.1 - MTC-2 and ACU auxiliary control unit

MTC-2 parts:

- 1) Battery connector – 4.8 – 7.4V battery input. **DO NOT REVERSE INPUT POLARITY TO AVOID DAMAGE!** Remove battery when not in use for long time.
- 2) RC receiver connectors – for 4 CH receivers, connect all connectors No.1 – 4. For 2 CH receivers, connect connectors No.1 and 2 only. CH5 is used for GSU on/off if GSU is connected.
- 3) Led indicator – multi-purpose indicator. When power on, it lights up 1 sec and then blinks slowly if it do not receive RC signal. It lights up continuously when signal is received from the RC connectors. It will also flash during the setup process. See setup procedures for details.
- 4) Setup button – setup MTC-2 for a particular transmitter. It also setup the gun reload position if R jumper is on. See setup procedures for details.
- 5) Dip switch 1 – gun turret type. Switched on for turret with 360° rotation. In this mode, a servo modified for continuous rotation is connected to ROT port to control turret rotation speed. When switched off, a standard servo is connected to ROT port to control the left/right gun movement.
- 6) Dip switch 2 – gun auto reload. Switched on to enable gun return to reload position after fire.
- 7) Dip switch 3 – turn mode. Switched on to enable pivot turning of tracks.
- 8) Dip switch 4 – shutdown voltage setting. Switched on to set shutdown voltage at 6V. This is suitable for 2 Cell Li-po battery. Switched off to set shutdown voltage at 3.3V. This is suitable for 1 Cell Li-po, or NiMH battery. See the input voltage section for more details.

ACU parts:

- 9) ROT port – turret rotation servo port. A continuous rotation servo is connected here to control turret rotation. For tanks with fixed turret, remove the G-jumper to set this port to left / right gun movement by standard servo.
- 10) ELV port – gun elevation servo port.
- 11) REC port – gun recoil servo port.
- 12) Speaker volume adjust – trimmer to change speaker volume.
- 13) SP port – speaker port, for driving 8Ohm / 1W speaker.
- 14) GF port – gun flash led port.
- 15) MF port – machine gun flash led port.
- 16) J1 jumper – remove jumper to turn off engine sounds.
- 17) GF and MG jumpers – for enable/disable of gun fire and machine gun fire. See Fig.1 for jumper settings.

Notes:

- 1) Lipo battery can be dangerous if not use properly:
 - always use a dedicated Lipo charger
 - do not short circuit to avoid explosion!!
 - follow all safety precautions of your Lipo and chargers
- 2) DO NOT REVERSE BATTERY POLARITY TO AVOID DAMAGE!!
- 3) Disconnect battery when not in use for long time.
- 4) To avoid interference, solder 1uF capacitor between power leads, and 0.1uF capacitors between motor case and power leads.
- 5) For 2 CH receivers, connect CH1 and CH2
- 6) CH5 is used to turn GSU on/off. See GSU manual for details.
- 7) Turret rotation servo must be modified to continuous rotation. See technical tips in the web page for details.

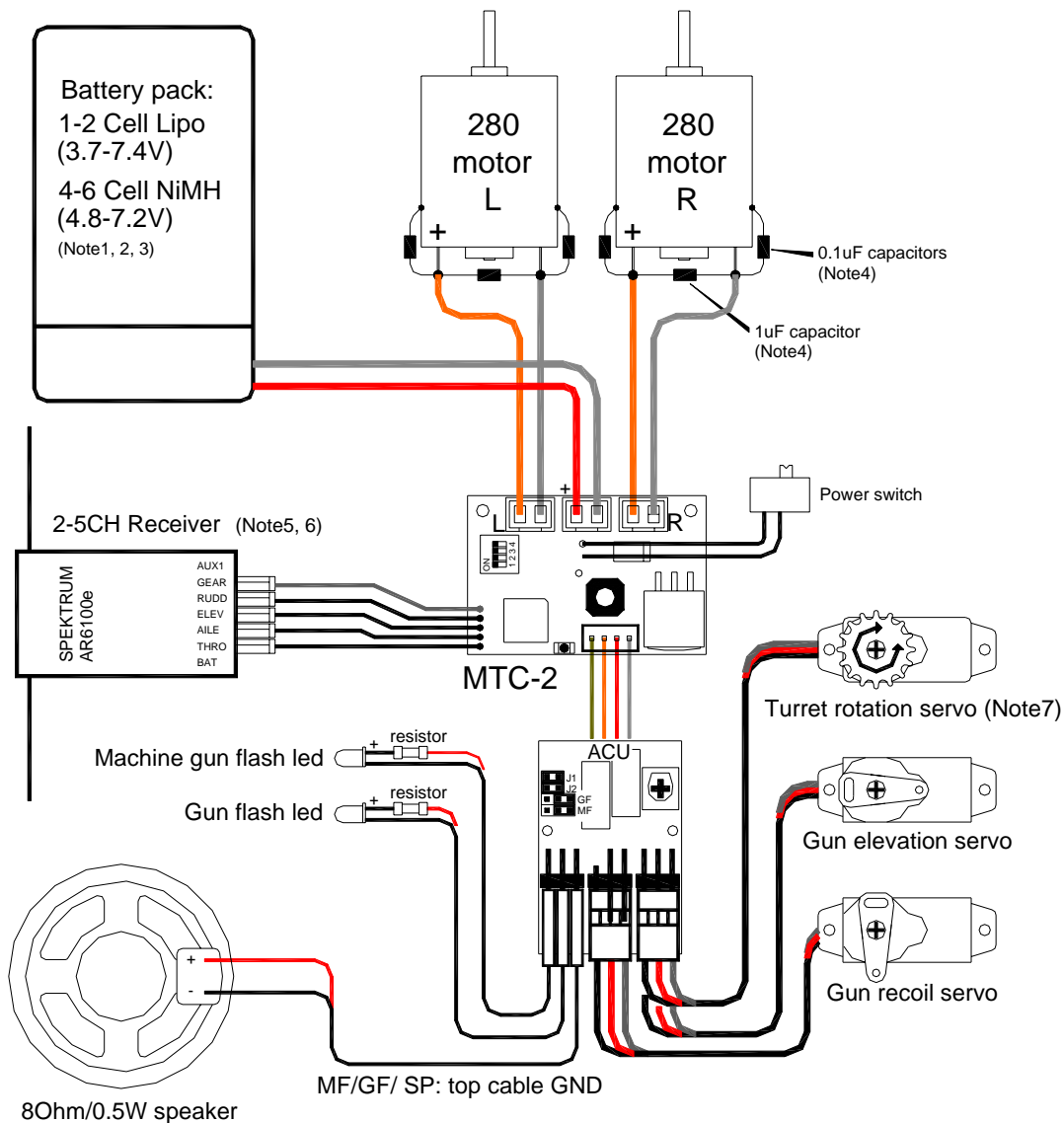

Fig.2 - Typical MTC-2 and ACU connection

Transmitter Stick Modes

The stick mode of MTC-2 is shown in Fig.3. If your transmitter has a different stick mode, change the connector numbers accordingly.

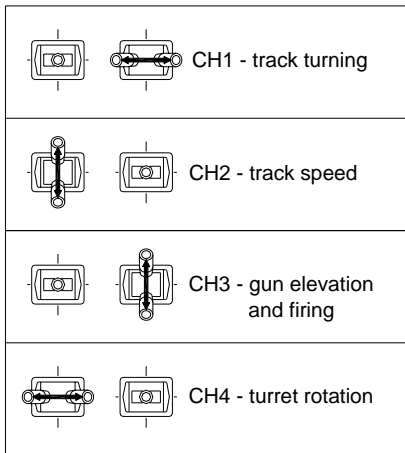
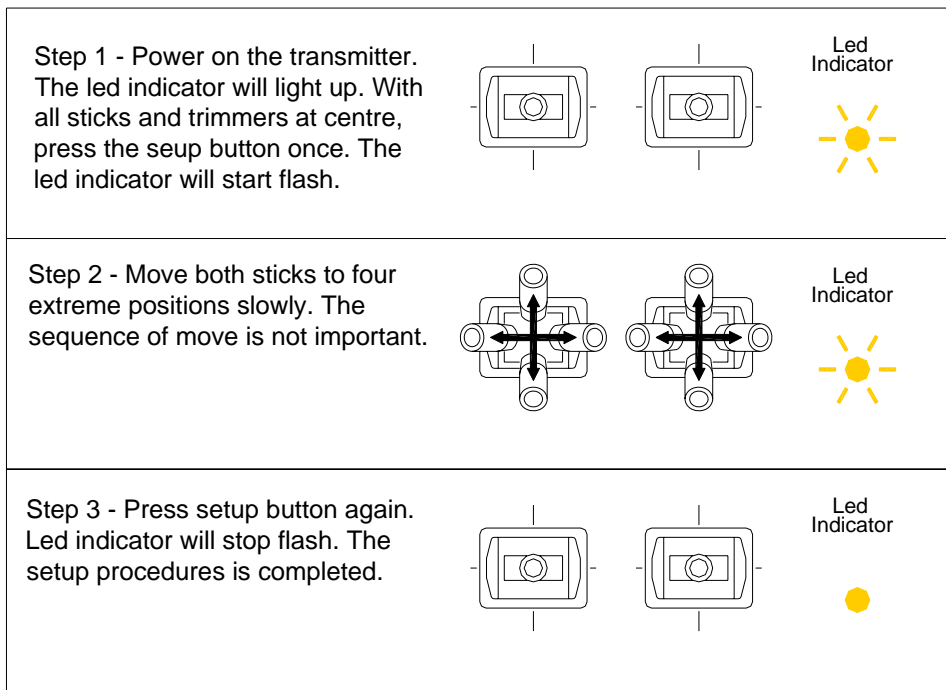

Fig.3 - Stick modes of MTC-2

Setup Procedures of MTC-2

When using MTC-2 for the first time, or when you change the transmitter, you must perform the setup procedures to store the transmitter characteristic in MTC-2. To avoid unintended track motion, disconnected motors or remove tracks during setup.



Setup Gun Reload Position

When dip switch 2 is on, gun will return to reload position after gun fire. To setup the gun reload position, move gun to the desired reload position and then press the setup button. You can go through the setup process as usual, or you can press the setup button at once to end setup.

Reset to Factory Settings

To reset to factory settings, press and hold the setup button until it stop flash. MTC-2 is then reset.

Track Motion Control

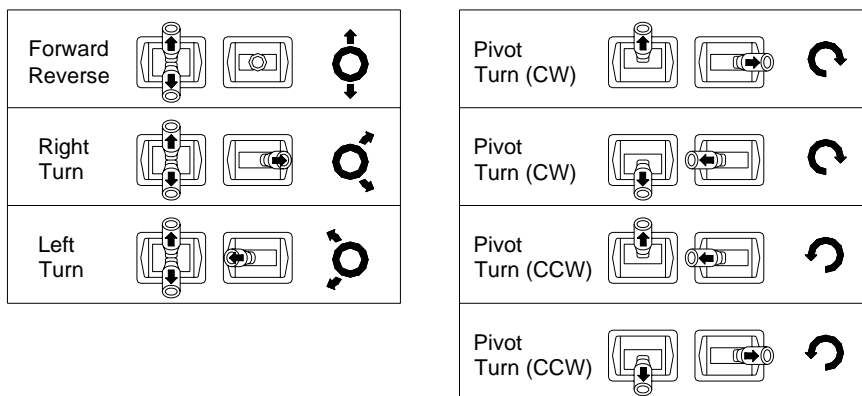

- Pivot turn begins when right stick move halfway left or right
- Pivot turn is disabled when dip switch 3 is switched off (Fig.1).

Brake Function

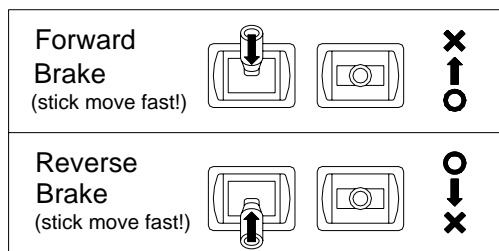

- Motors stops instantly when left stick moves fast backward.
- After brake, left stick must move back to center to restart track motion.
- Brake action however is not enabled at very low speed.

Turret Motion Control

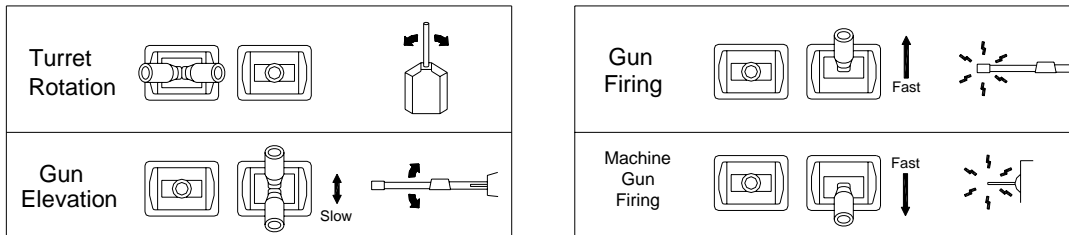

- To trigger gun firing, move right stick quickly from middle to top. Tank will recoil during gun fire. After gun fire, move stick back to middle to resume operation.
- To trigger machine gun firing, move right stick quickly from middle to bottom. Machine gun sound continuous when stick keep at bottom. Move stick back to middle to resume operation.
- Both sound effects can be disabled by jumper settings (Fig.1).

Engine Sound Control

Engine sound will be generated when ACU is connected and J1 installed:

Engine start – trigger by first throttle.

Engine idling – when tank not running, turning stick position controls engine speed. Move turning stick slowly to left or right will increase engine speed.

Running – when tank in running, engine speed changes according to speed.

Engine stop – with throttle at center, move turning stick quickly to left or right extreme position for 5 sec.

Alternatively, engine will stop in 5 sec after transmitter is turned off.

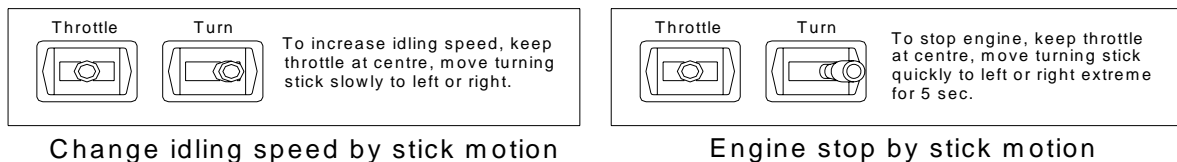

Input Voltage

- MTC-2 is designed to work at 4.8 - 7.4V (4 - 6 cell 1.2V NiMH, or 2 cell Lipo battery). To avoid over discharge of Lipo battery, it will shutdown automatically when input voltage is too low. After shutdown, the motors will stop and led indicator flashes slowly. Also, the ACU beeps if connected.
- Dip switch 4 determines the shutdown voltage. When switched on, the shutdown voltage is set at 6V. It is suitable for 2 cell Lipo. When switched off, the shutdown voltage is set at 3.3V. It is suitable for NiMH and 1C Lipo.
- When using 4 cell NiMH or 1C Lipo, operation becomes unstable when input voltage drops below 4V. This may happens before auto shutdown and you should replace the battery.
- When using Lipo battery, follow all safety precautions and always disconnect battery after use.

Troubleshooting

Symptom	Cause	Resolution
Led blinks when tank moves Tank out of control	Motor interference Low battery	<ul style="list-style-type: none"> - Add noise filtering capacitors (Fig.2) - Keep antenna away from motors cables - Prevent loose metal contacts - Motor fault, replace motor - Replace or recharge battery
Led indicator not stable, or turns off	Antenna problems	<ul style="list-style-type: none"> - Check antenna length - Keep antenna in vertical position - Keep antenna away from motors cables
Led indicator dims when tank moves	Low battery	<ul style="list-style-type: none"> - Replace or recharge battery
Cannot trigger main gun / machine gun	Improper setup	<ul style="list-style-type: none"> - Do setup again
	Wrong jumper setting	<ul style="list-style-type: none"> - Check GF, MF jumpers