

RC Conversion Kit for Tamiya 1/35 M1A1/A2 Tank

User Manual

Attention!

- 1) This kit is designed for experienced model makers. It may be difficult for beginners. Please read this manual thoroughly to see if you have the required skills and tools.
- 2) Cutting tools are used frequently in this kit. Extra care should be taken to avoid injury. Wear hand gloves and eye protection spectacle if necessary.
- 3) Keep room well ventilated when working with cements, paints and organic solvents.
- 4) Visit www.35rctank.com for addition tips and update information.

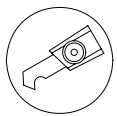

scriber



apply cement



side cutter



do not apply cement

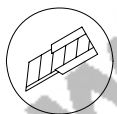

modelling knife



apply instant glue

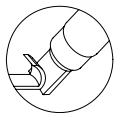

carving knife



wait overnight



Attention!

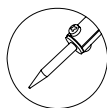

solder

1 Lower hull

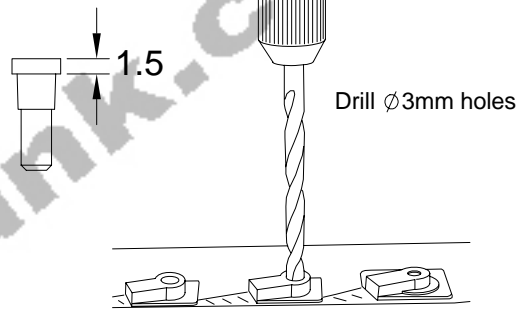
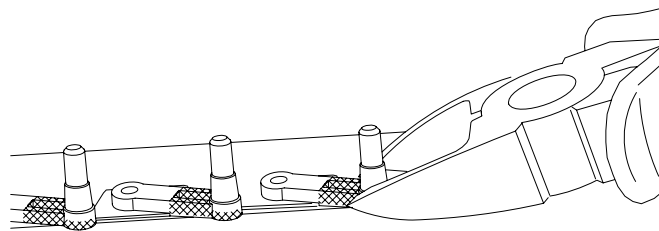
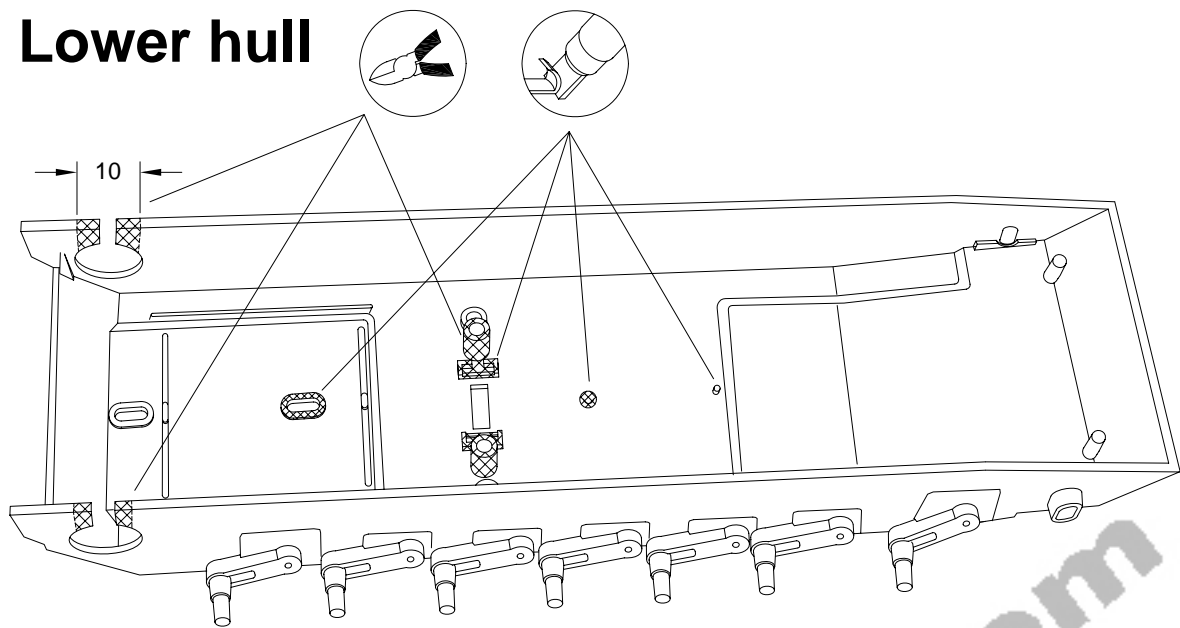

⚠ Remove wheel shaft carefully. Collect 14 wheel shafts for later use.

2A Suspension arms

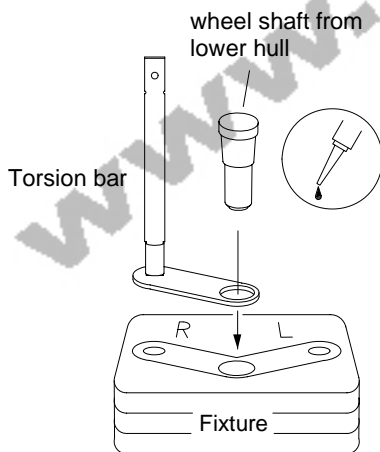

Place torsion bar on top of fixture. Note different position for left and right arms. Insert wheel shaft and apply instant glue carefully.

Attention - Too much glue will stick arm to fixture!

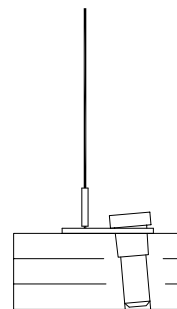

⚠ The suspension arms will tilt under loading. The shaft is tilt in purpose for compensation.

